



● NPG GEL Series Battery

NPG Series batteries are designed with special separator and GEL deep cycle technology to give Extra-durable cyclic performance at extreme temperature.

NPG series Batteries are the DEEP CYCLE batteries with 18 years floating design life at 25 °C.

Meet with IEC, BS,JIS and Eurobat standard .

● Application

- *Emergency Power System
- *Communication equipment
- *Telecommunication systems
- *Uninterruptible power supplies
- *Electric bicycle and wheelchairs, etc
- *Power tools
- *Alarm system
- *Marine equipment
- *Fire and Security System
- *Solar and Wind System.



● General Features

- *Safety Sealing
- *Non-spillable construction
- *High Reliability and Stability
- *Sealed and Maintenance-free
- *Safety and Quality certification
- *Long Life and low self-discharge design

● Construction

- *PositiveLead dioxide
- *ElectrolyteSulfuric acid thixotropic gel
- *SeparatorMacromolecule polymer
- *ContainerABS(UL94-HB), Flammability Resistance of UL94-V2 can be available upon request
- *NegativeLead
- *Safety ValveEPDR
- *TerminalCopper

● Specification

Battery Model	Nominal Voltage		2V	
	Rated capacity(10 Hour rate)		200Ah	
Dimensions	Length	Width	Height	Total Height
	172mm (6.77 inches)	111mm(4.37 inches)	329mm(12.95 inches)	356mm (14.02 inches)
Approx Weight	14.0kg(30.86lbs)±3%			
Capacity 25°C (77°F)	10 Hour rate(20A,1.80V)	5 Hour rate (34A,1.75V)	3 Hour rate (50A,1.70V)	1 Hour rate (110A,1.60V)
	200Ah	170Ah	150Ah	110Ah
Max.discharge current	2000A(5 Sec.)			
Internal Resistance	Full charged at 25 °C (77°F): Approx 0.65mΩ			
Capacity affected by Temp. (10 HR)	40°C (104 °F)	25°C (77°F)	0°C (32°F)	-15°C (5°F)
	102%	100%	85%	65%
Self Discharge at 25°C (77°F)	After 3 months storage		After 6 months storage	After 12 months storage
	91%		82%	64%
Charge method 25°C (77°F)	Cycle Use		Float Use	
	2.35-2.40V (Initial charging current less than 80A)		2.25-2.30V	

● Outer dimensions (mm)

● Terminal Type (mm)

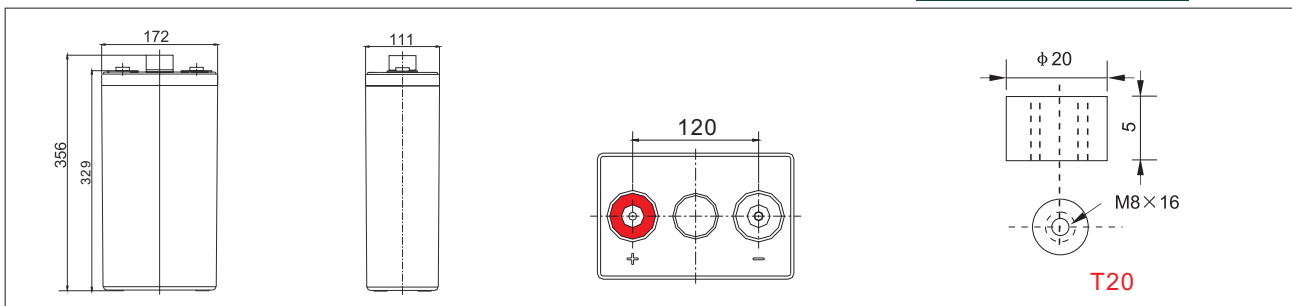

Constant Current(Amp) and Constant Power(Watt) Discharge Table at 25°C (77°F)

Time		5min	10min	15min	30min	1hr	2hr	3hr	4hr	5hr	8hr	10hr	20hr
1.60V	A	641	422	340	228	120.0	70.0	51.4	40.0	33.0	23.4	21.0	11.3
	W	1102	751	608	409	216.0	128.1	95.3	75.0	62.5	44.7	40.4	22.0
1.70V	A	620	381	320	218	112.8	66.8	50.0	39.0	32.4	22.8	20.6	11.0
	W	1104	709	598	408	212.6	128.3	96.5	75.6	63.0	44.5	40.3	21.5
1.75V	A	600	341	280	204	109.2	65.2	48.8	38.4	32.0	22.6	20.2	11.0
	W	1092	646	533	391	210.8	126.0	94.8	74.9	62.5	44.3	39.8	21.7
1.80V	A	578	321	260	188	105.6	63.6	47.6	37.8	31.2	22.0	20.0	10.8
	W	1082	617	500	363	204.9	124.1	93.5	74.4	61.5	43.5	39.6	21.4
1.85V	A	559	301	240	168	102.0	62.0	46.0	36.8	30.4	21.4	19.0	10.2
	W	1057	581	466	328	199.9	122.1	91.1	73.0	60.5	42.7	38.2	20.6



Discharge characteristic Curve

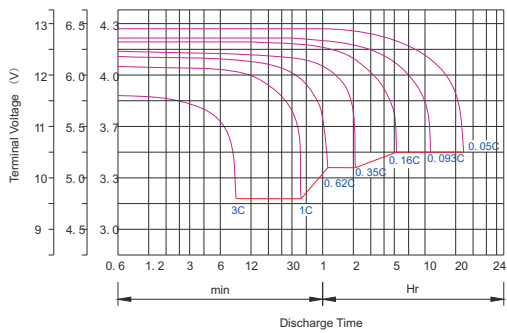

Cycle service life in relation to depth of discharge

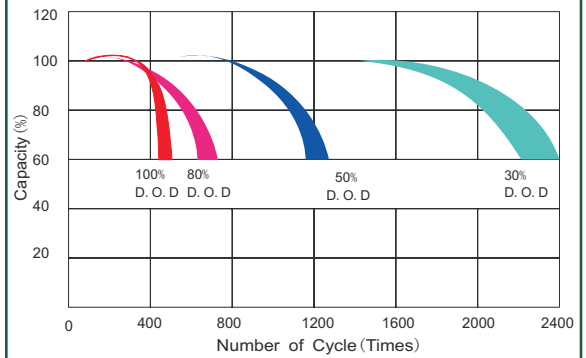

Relationship between charging voltage and temperature

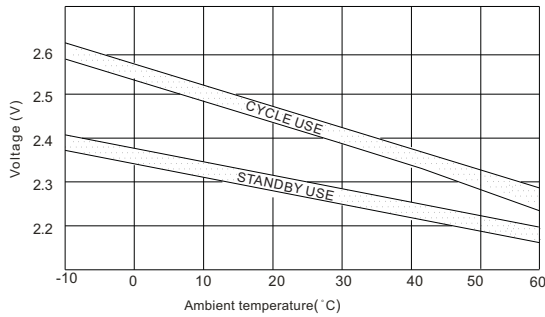

Constant voltage charging characteristic (0.25CA, at 25°C)

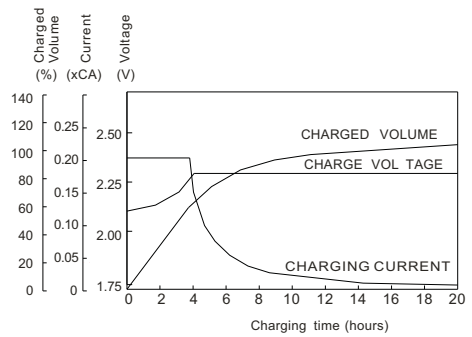

Life characteristics of standby use

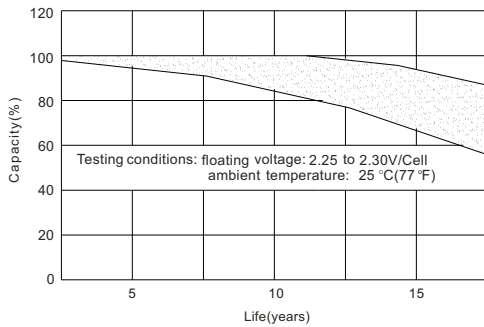

Self-discharge characteristic

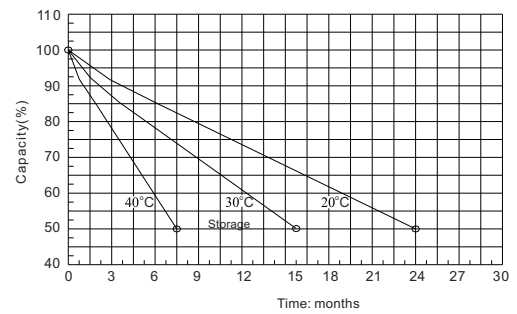

Temperature effects on float life

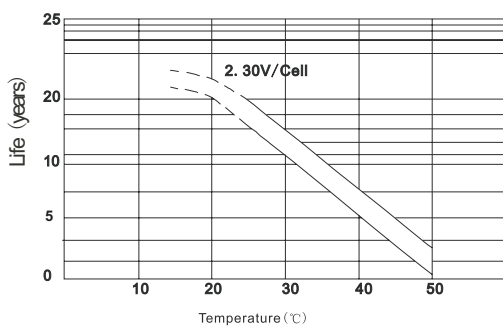

Charge characteristic Curve for standby use

